



Acoustic cabinet fans manufactured from heavy gauge galvanised steel sheet and internally lined with 50 mm thickness of fireproof acoustic fiberglass insulation (M0). Fan cover supplied with "quick-fix" fixings to enable fast removal and fitting, and a tight close. All models incorporate single phase direct-drive forward curved centrifugal fan. All fans installed in acoustic cabinet fans CAB comply with the efficiency requirements of the ErP Directive.

All cabinets can be installed outdoors as standard.
Available, depending upon the model, with single motors in 2 or 4 poles.

Motors

- From CAB-100 to CAB-250N, motors are IP44, class B with ball bearings and thermal protection.
- CAB-315 RE model is fitted with an IP44 class F motor with ball bearings and thermal protection.
- CAB-355 RE and 400 RE models are fitted with an IP55 class F motor with ball bearings and thermal protection.

Electrical supply:

- Single-phase 230V 50/60Hz from CAB-100 to 160
- Single-phase 230V 50Hz from CAB-200 to 400 RE

Speed controllable using voltage regulation.

Working temperature from -20°C to +40°C.

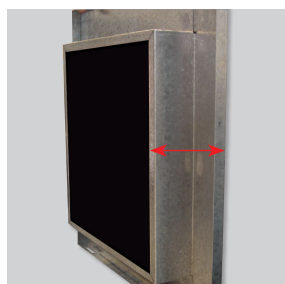

Low noise level

Acoustic insulation of 50 mm thickness fireproof fibreglass (M0) with a high resistance coating reducing the noise level significantly.



Cabinet air tightness

All models incorporate inlet and discharge circular duct connection flanges with integrated rubber air seal.



IP55 remote terminal box

To ease installation and connection to external controls.



Easy maintenance

"Quick fix" fixings to enable a fast and easy maintenance.



Easy to install

All models are supplied with four mounting feet to facilitate any ceiling, wall or floor mounting installation.

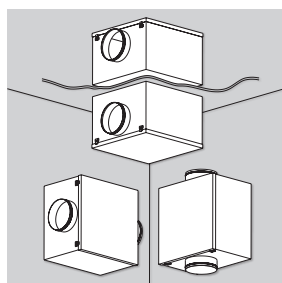

Installation in any position

Can be mounted in vertical, horizontal or inverted position.

TECHNICAL CHARACTERISTICS

Before installation check that the product electrical characteristics listed on the data plate label (voltage, power, frequency, etc.) match those of the intended electrical supply.

Model	Fan size	Speed (rpm)	Max.abs. power (W)	Max.abs. current at 230V (A)	Max. airflow (m³/h)	Sound pressure level** (dB(A))			Min-Max air temperature (°C)	Weight (kg)	Speed controller	Wiring diagram (n°)
						Inlet	Outlet	Radiated*				
CAB-100	140/059	1390	42	0,18	190	30	44	29	-20/+40	16	REB-1N	50
CAB-125	140/059	1190	43	0,19	220	29	45	28	-20/+40	16	REB-1N	50
CAB-150	140/059	1580	93	0,41	350	39	53	35	-20/+40	18	REB-1N	50
CAB-160	140/059	1740	94	0,41	360	39	53	35	-20/+40	18	REB-1N	50
CAB-200	133/126	2330	299	1,26	920	48	65	46	-20/+40	22	REB-2,5N	50
CAB-250 N	146/180	1550	395	1,73	1180	46	63	38	-20/+40	27	REB-2,5N	50
CAB-315 RE	7/9	1280	357	1,53	2110	48	60	45	-20/+40	33	REB-2,5N	51
CAB-355 RE	9/9	1330	861	4,13	3200	51	65	45	-20/+40	35	REB-5	51
CAB-400 RE	9/9	1330	870	4,09	3080	53	66	47	-20/+40	35	REB-5	51

* Fan ducted on both inlet and outlet sides.

** Sound pressure levels measured at 1,5m in free field condition at a medium working point of the performance curve

DIMENSIONS (mm)

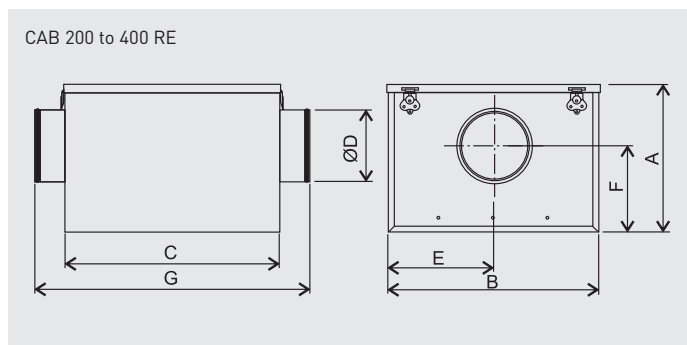
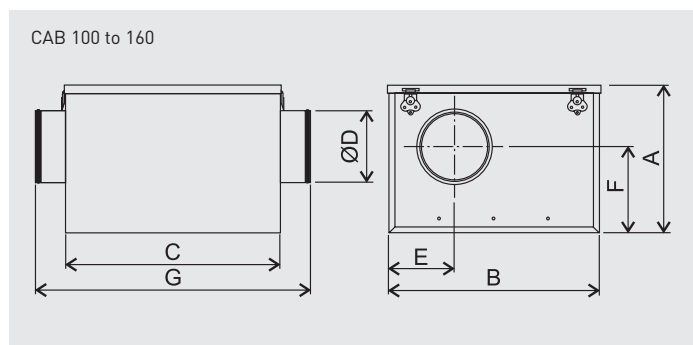

Model	A	B	C	Ø D	E	F	G
CAB-100	273	388	395	100	125	162	505
CAB-125	273	388	395	125	125	162	505
CAB-150	273	388	395	150	143	162	505
CAB-160	273	388	395	160	143	162	505
CAB-200	328	430	365	200	216	210	475
CAB-250N	383	525	450	250	263	237	560
CAB-315 RE	443	600	505	315	301	264	615
CAB-355 RE	513	660	600	355	331	292	710
CAB-400 RE	513	660	600	400	331	292	710

PERFORMANCE CURVES

- q_v : Airflow in m^3/h .
- p_{sf} : Static pressure in Pa.
- Dry air at 20°C and 760 mmHg.
- Performance data in accordance with ISO 5801 and AMCA 210-99 Standards.
- SFP: Specific fan power in $W/m^3/s$ (blue curves).

CAB-100

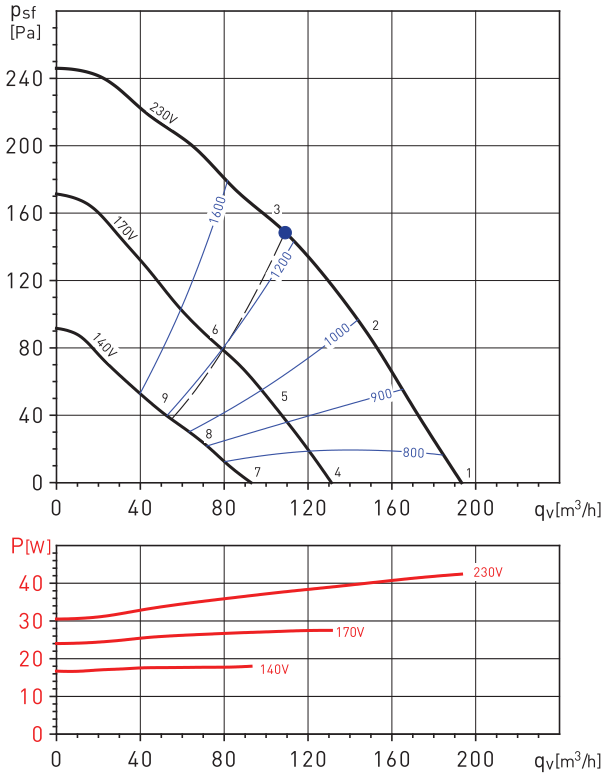

CAB-125

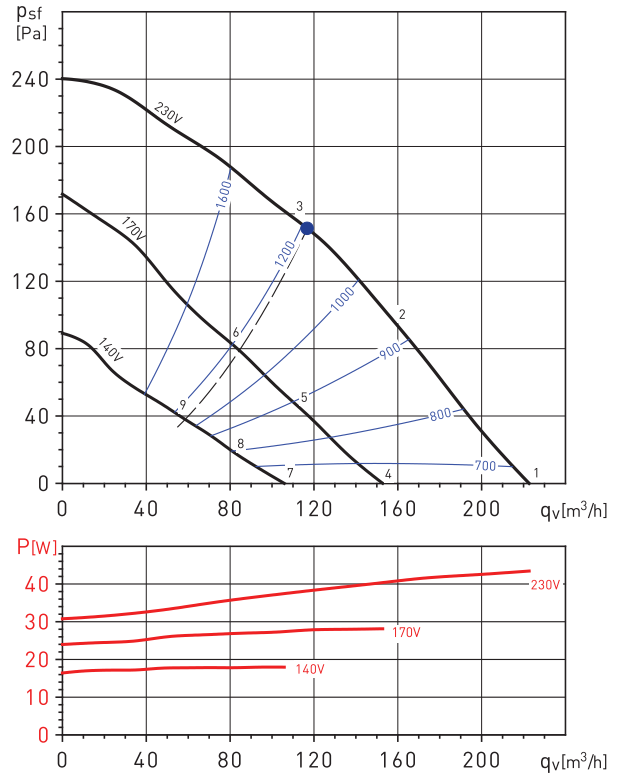

Sound power level spectrums in dB(A)

Working point		63	125	250	500	1000	2000	4000	8000	LwA
1	Inlet	38	42	35	36	35	32	28	24	45
	Outlet	32	46	43	46	55	52	48	45	58
	Break-Out	38	39	34	35	33	30	28	24	44
2	Inlet	38	41	35	34	34	32	27	25	45
	Outlet	34	44	42	46	56	53	48	44	59
	Break-Out	38	38	34	33	32	30	27	25	43
3	Inlet	40	45	37	35	36	35	30	25	48
	Outlet	35	48	45	49	57	54	50	46	60
	Break-Out	40	42	36	34	34	33	30	25	46
4	Inlet	29	33	26	27	26	23	19	15	37
	Outlet	23	37	34	37	46	43	39	36	49
	Break-Out	29	30	25	26	24	21	19	15	35
5	Inlet	32	35	29	28	28	26	21	19	38
	Outlet	26	36	34	38	48	45	40	36	51
	Break-Out	32	32	28	27	26	24	21	19	37
6	Inlet	34	39	31	29	30	29	24	19	42
	Outlet	28	41	38	42	50	47	43	39	53
	Break-Out	34	36	30	28	28	27	24	19	40
7	Inlet	22	26	19	20	19	16	12	8	29
	Outlet	16	30	27	30	39	36	32	29	42
	Break-Out	22	23	18	19	17	14	12	8	28
8	Inlet	24	27	21	20	20	18	13	11	30
	Outlet	18	28	26	30	40	37	32	28	43
	Break-Out	24	24	20	19	18	16	13	11	29
9	Inlet	26	31	23	21	22	21	16	11	34
	Outlet	20	33	30	34	42	39	35	31	45
	Break-Out	26	28	22	20	20	19	16	11	32

Sound power level spectrums in dB(A)

Working point		63	125	250	500	1000	2000	4000	8000	LwA
1	Inlet	36	42	35	35	33	30	29	25	45
	Outlet	33	44	43	50	56	53	49	45	59
	Break-Out	36	41	35	32	30	27	22	20	44
2	Inlet	35	40	35	33	33	30	29	25	44
	Outlet	32	43	42	49	56	54	49	45	59
	Break-Out	35	39	35	30	30	27	22	20	42
3	Inlet	40	45	37	35	36	35	30	25	48
	Outlet	35	48	45	49	57	54	50	46	60
	Break-Out	40	44	37	32	33	32	23	20	47
4	Inlet	24	30	23	23	21	18	17	13	33
	Outlet	21	32	31	38	44	41	37	33	47
	Break-Out	24	29	23	20	18	15	10	8	32
5	Inlet	27	32	27	25	25	22	21	17	35
	Outlet	22	33	32	39	46	44	39	35	50
	Break-Out	27	31	27	22	22	19	14	12	34
6	Inlet	32	37	29	27	28	27	22	17	40
	Outlet	26	39	36	40	48	45	41	37	51
	Break-Out	32	36	29	24	25	24	15	12	39
7	Inlet	16	22	15	15	13	10	9	5	25
	Outlet	13	24	23	30	36	33	29	25	39
	Break-Out	16	21	15	12	10	7	2	0	24
8	Inlet	19	24	19	17	17	14	13	9	28
	Outlet	15	26	25	32	39	37	32	28	42
	Break-Out	19	23	19	14	14	11	6	4	26
9	Inlet	25	30	22	20	21	20	15	10	33
	Outlet	19	32	29	33	41	38	34	30	44
	Break-Out	25	29	22	17	18	17	8	5	32

PERFORMANCE CURVES

- q_v : Airflow in m^3/h .
- p_{sf} : Static pressure in Pa.
- Dry air at 20°C and 760 mmHg.
- Performance data in accordance with ISO 5801 and AMCA 210-99 Standards.
- SFP: Specific fan power in $W/m^3/s$ (blue curves).

CAB-150

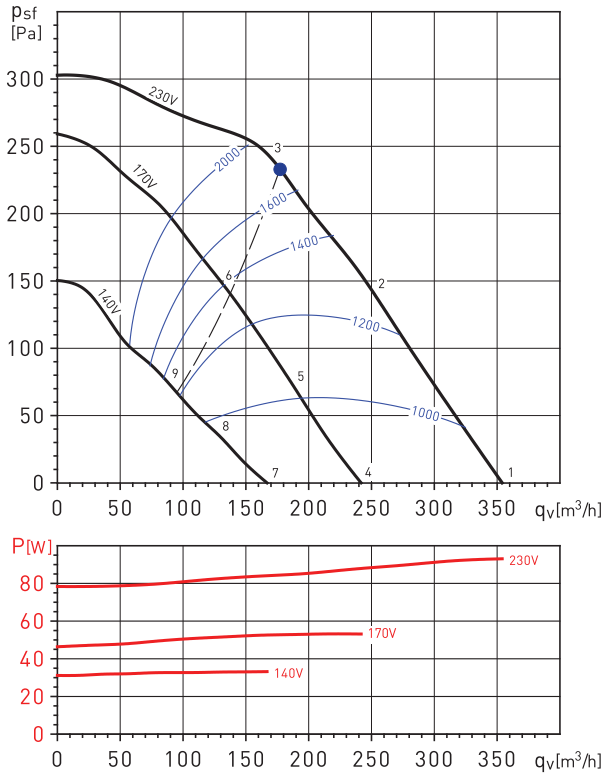

CAB-160

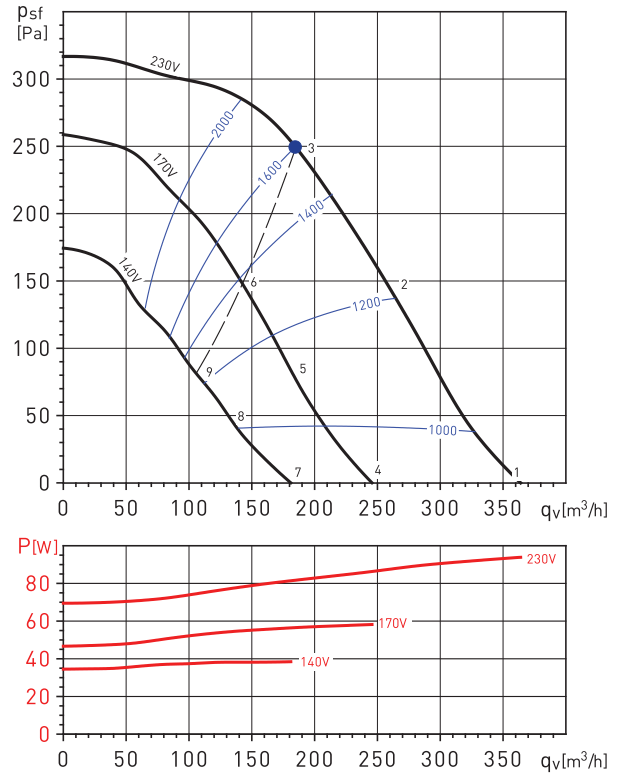

Sound power level spectrums in dB(A)

Working point	63	125	250	500	1000	2000	4000	8000	LwA	
1	Inlet	46	53	45	44	41	41	37	56	
	Outlet	40	56	56	59	65	63	59	69	
	Break-Out	46	49	40	40	41	34	31	28	52
2	Inlet	41	51	43	42	43	41	41	36	53
	Outlet	35	53	53	57	63	62	58	56	67
	Break-Out	41	47	38	37	40	34	31	27	49
3	Inlet	42	49	41	42	44	43	40	36	53
	Outlet	35	51	50	56	63	62	57	55	67
	Break-Out	42	45	36	37	41	36	30	27	49
4	Inlet	37	44	36	36	35	32	32	28	47
	Outlet	31	47	47	50	56	54	50	48	60
	Break-Out	37	40	31	31	32	25	22	19	43
5	Inlet	34	44	36	35	36	34	34	29	46
	Outlet	28	46	46	50	56	55	51	49	60
	Break-Out	34	40	31	30	33	27	24	20	42
6	Inlet	36	43	35	36	38	37	34	30	46
	Outlet	29	45	44	50	57	56	51	49	61
	Break-Out	36	39	30	31	35	30	24	21	42
7	Inlet	29	36	28	28	27	24	24	20	39
	Outlet	23	39	39	42	48	46	42	40	52
	Break-Out	29	32	23	23	24	17	14	11	35
8	Inlet	26	36	28	27	28	26	26	21	38
	Outlet	20	38	38	42	48	47	43	41	52
	Break-Out	26	32	23	22	25	19	16	12	34
9	Inlet	28	35	27	28	30	29	26	22	39
	Outlet	21	37	36	42	49	48	43	41	53
	Break-Out	28	31	22	23	27	22	16	13	35

Sound power level spectrums in dB(A)

Working point	63	125	250	500	1000	2000	4000	8000	LwA	
1	Inlet	47	54	45	44	44	42	44	40	56
	Outlet	41	57	55	60	65	63	59	57	69
	Break-Out	47	50	40	39	41	37	35	30	53
2	Inlet	42	50	42	41	42	41	43	39	53
	Outlet	36	53	52	58	64	62	58	56	68
	Break-Out	42	46	37	36	39	36	34	29	49
3	Inlet	42	49	41	41	43	41	42	38	52
	Outlet	36	51	50	57	63	62	57	54	67
	Break-Out	42	45	36	36	40	36	33	28	49
4	Inlet	40	47	38	37	37	35	37	33	49
	Outlet	35	51	49	54	59	57	53	51	63
	Break-Out	40	43	33	32	34	30	28	23	45
5	Inlet	36	44	36	35	36	35	37	33	47
	Outlet	30	47	46	52	58	56	52	50	62
	Break-Out	36	40	31	30	33	30	28	23	43
6	Inlet	36	43	35	35	37	35	36	32	46
	Outlet	30	45	44	51	57	56	51	48	61
	Break-Out	36	39	30	30	34	30	27	22	43
7	Inlet	32	39	30	29	29	27	29	25	42
	Outlet	27	43	41	46	51	49	45	43	55
	Break-Out	32	35	25	24	26	22	20	15	38
8	Inlet	29	37	29	28	29	28	30	26	40
	Outlet	23	40	39	45	51	49	45	43	55
	Break-Out	29	33	24	23	26	23	21	16	36
9	Inlet	30	37	29	29	31	29	30	26	40
	Outlet	24	39	38	45	51	50	45	42	55
	Break-Out	30	33	24	24	28	24	21	16	36

PERFORMANCE CURVES

- q_v : Airflow in m^3/h .
- p_{st} : Static pressure in Pa.
- Dry air at 20°C and 760 mmHg.
- Performance data in accordance with ISO 5801 and AMCA 210-99 Standards.
- SFP: Specific fan power in $W/m^3/s$ (blue curves).

CAB-200

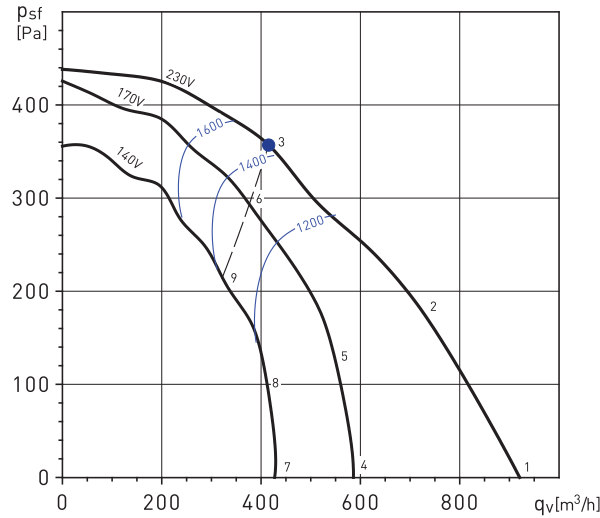

CAB-250N

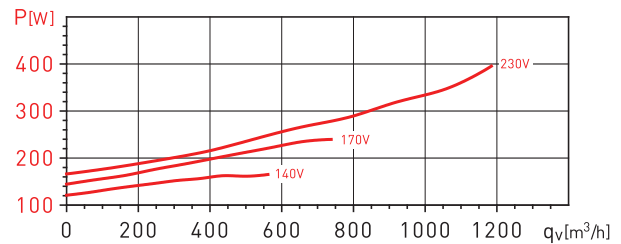
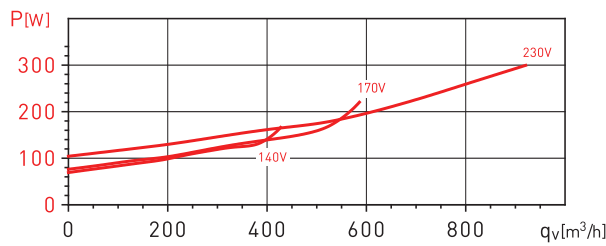
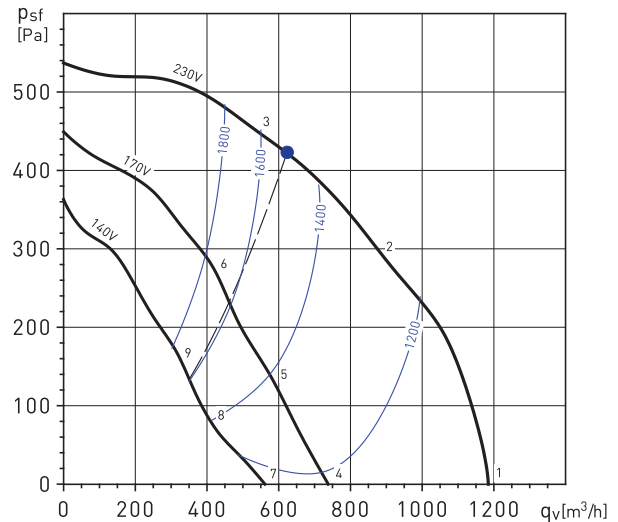

Sound power level spectrums in dB(A)

Working point	63	125	250	500	1000	2000	4000	8000	LwA	
1	Inlet	52	61	58	59	56	57	57	52	66
	Outlet	48	64	65	70	76	78	74	72	82
	Break-Out	52	61	54	53	52	53	47	42	64
2	Inlet	52	57	53	55	53	54	54	49	63
	Outlet	46	60	62	68	74	76	72	69	80
	Break-Out	52	57	49	49	49	50	44	39	60
3	Inlet	51	57	52	52	51	51	50	44	61
	Outlet	49	61	61	65	70	72	68	64	76
	Break-Out	51	57	48	46	47	47	40	34	59
4	Inlet	41	50	47	48	45	46	46	41	56
	Outlet	37	53	54	59	65	67	63	61	71
	Break-Out	41	50	43	42	41	42	36	31	53
5	Inlet	46	51	47	49	47	48	48	43	57
	Outlet	40	54	56	62	68	70	66	63	74
	Break-Out	46	51	43	43	43	44	38	33	54
6	Inlet	48	54	49	49	48	48	47	41	59
	Outlet	46	58	58	62	67	69	65	61	74
	Break-Out	48	54	45	43	44	44	37	31	57
7	Inlet	35	44	41	42	39	40	40	35	50
	Outlet	31	47	48	53	59	61	57	55	65
	Break-Out	35	44	37	36	35	36	30	25	47
8	Inlet	40	45	41	43	41	42	42	37	51
	Outlet	34	48	50	56	62	64	60	57	68
	Break-Out	40	45	37	37	37	38	32	27	48
9	Inlet	46	52	47	47	46	46	45	39	56
	Outlet	44	56	56	60	65	67	63	59	71
	Break-Out	46	52	43	41	42	42	35	29	54

Sound power level spectrums in dB(A)

Working point	63	125	250	500	1000	2000	4000	8000	LwA	
1	Inlet	49	54	50	49	48	51	48	42	59
	Outlet	45	55	57	63	71	70	67	64	75
	Break-Out	39	47	42	41	44	44	40	33	52
2	Inlet	52	54	52	51	48	54	49	42	60
	Outlet	51	59	60	67	71	74	69	64	77
	Break-Out	41	47	44	43	44	47	41	33	53
3	Inlet	55	56	55	52	51	58	51	45	63
	Outlet	51	62	62	70	74	77	73	68	81
	Break-Out	45	49	47	44	48	51	43	36	56
4	Inlet	39	44	40	39	38	40	38	32	49
	Outlet	35	45	47	53	61	60	57	53	65
	Break-Out	28	37	32	31	34	34	30	23	42
5	Inlet	43	45	44	42	39	45	40	33	52
	Outlet	42	50	51	59	62	66	61	56	69
	Break-Out	33	38	35	35	36	39	32	25	44
6	Inlet	50	50	49	46	46	52	46	39	58
	Outlet	46	56	57	64	68	72	68	62	75
	Break-Out	40	43	41	39	42	46	38	30	50
7	Inlet	34	39	35	34	33	35	33	27	44
	Outlet	30	40	42	48	56	55	52	48	60
	Break-Out	23	32	26	26	29	29	25	18	37
8	Inlet	36	38	37	35	32	38	34	27	45
	Outlet	35	43	45	52	55	59	54	49	62
	Break-Out	26	31	29	28	29	32	25	18	38
9	Inlet	44	45	44	41	40	47	40	34	52
	Outlet	40	51	51	59	63	66	62	57	70
	Break-Out	34	38	36	33	37	40	32	25	45

PERFORMANCE CURVES

- q_v : Airflow in m^3/h .
- p_{sf} : Static pressure in Pa.
- Dry air at 20°C and 760 mmHg.
- Performance data in accordance with ISO 5801 and AMCA 210-99 Standards.
- SFP: Specific fan power in $W/m^3/s$ (blue curves).

CAB-315 RE

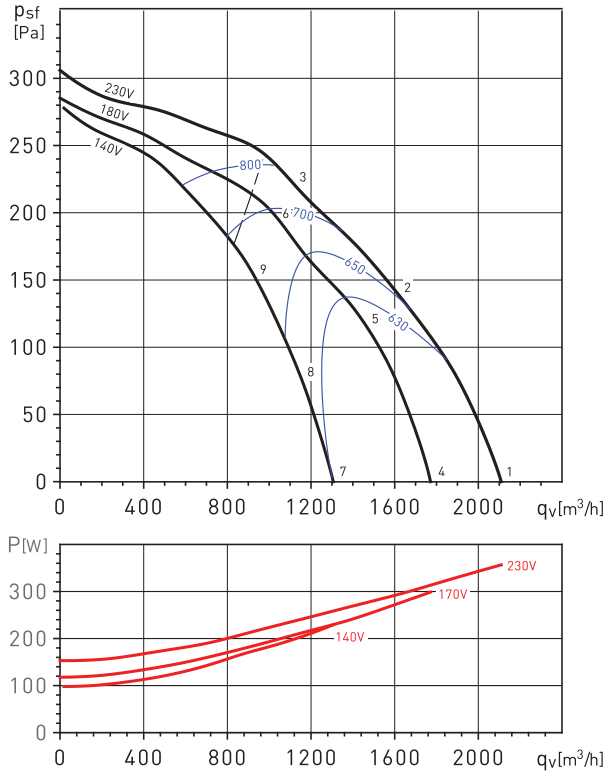

CAB-355 RE

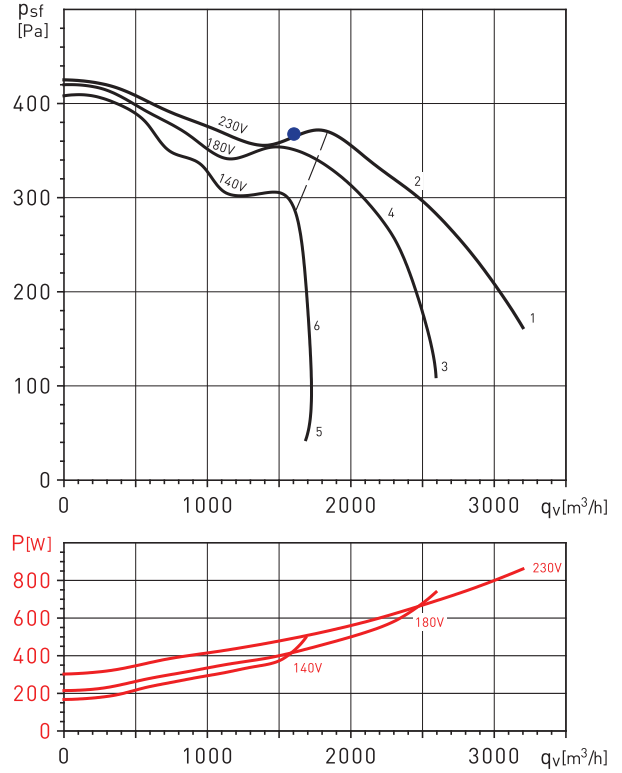

Sound power level spectrums in dB(A)

Working point		63	125	250	500	1000	2000	4000	8000	LwA
1	Inlet	55	59	60	55	57	55	50	41	65
	Outlet	59	63	64	70	74	71	67	62	78
	Break-Out	52	59	54	51	52	51	49	32	62
2	Inlet	53	55	56	52	55	53	47	38	62
	Outlet	51	59	61	67	71	68	64	58	75
	Break-Out	50	55	50	48	50	49	46	29	59
3	Inlet	55	56	54	51	53	51	45	38	62
	Outlet	51	58	58	65	69	67	62	56	73
	Break-Out	52	56	48	47	48	47	44	29	59
4	Inlet	52	56	57	52	54	52	47	38	62
	Outlet	56	60	61	67	71	68	64	59	75
	Break-Out	49	56	51	48	49	48	46	29	59
5	Inlet	51	53	54	50	53	51	45	36	60
	Outlet	49	57	59	65	69	66	62	56	73
	Break-Out	48	53	48	46	48	47	44	27	57
6	Inlet	54	55	53	50	52	50	44	37	60
	Outlet	50	57	57	64	68	66	61	55	72
	Break-Out	51	55	47	46	47	46	43	28	58
7	Inlet	44	48	49	44	46	44	39	30	55
	Outlet	48	52	53	59	63	60	56	51	67
	Break-Out	41	48	43	40	41	40	38	21	52
8	Inlet	46	48	49	45	48	46	40	31	55
	Outlet	44	52	54	60	64	61	57	51	68
	Break-Out	43	48	43	41	43	42	39	22	52
9	Inlet	51	52	50	47	49	47	41	34	57
	Outlet	47	54	54	61	65	63	58	52	69
	Break-Out	48	52	44	43	44	43	40	25	55

Sound power level spectrums in dB(A)

Working point		63	125	250	500	1000	2000	4000	8000	LwA
1	Inlet	55	60	63	57	61	61	58	49	68
	Outlet	60	64	68	73	79	78	77	71	84
	Break-Out	50	55	57	51	56	54	54	45	63
2	Inlet	53	57	58	54	60	58	54	45	65
	Outlet	55	60	64	69	75	73	72	65	79
	Break-Out	48	52	52	48	55	51	50	41	60
3	Inlet	50	55	58	52	56	56	53	44	64
	Outlet	55	59	63	68	74	73	72	66	79
	Break-Out	45	50	52	46	51	49	49	40	58
4	Inlet	51	55	56	52	58	56	52	43	64
	Outlet	53	58	62	67	73	71	70	63	78
	Break-Out	46	50	50	46	53	49	48	39	58
5	Inlet	40	45	48	42	46	46	43	34	54
	Outlet	45	49	53	58	64	63	62	56	69
	Break-Out	35	40	42	36	41	39	39	30	48
6	Inlet	44	48	49	45	51	49	45	36	56
	Outlet	46	51	55	60	66	64	63	56	70
	Break-Out	39	43	43	39	46	42	41	32	51

PERFORMANCE CURVES

- q_v : Airflow in m^3/h .
- p_{sf} : Static pressure in Pa.
- Dry air at 20°C and 760 mmHg.
- Performance data in accordance with ISO 5801 and AMCA 210-99 Standards.
- SFP: Specific fan power in $W/m^3/s$ (blue curves).

CAB-400 RE

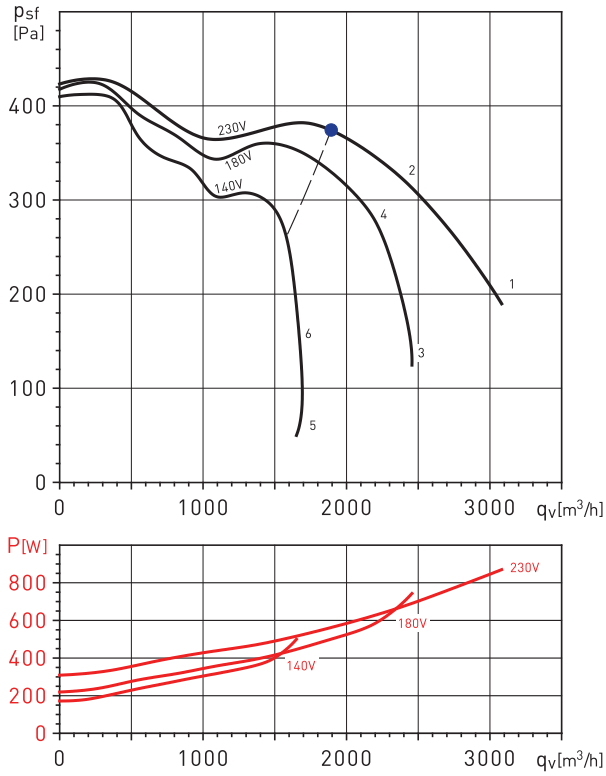

Sound power level spectrums in dB(A)

Working point	63	125	250	500	1000	2000	4000	8000	LwA	
1	Inlet	55	61	64	59	63	63	61	52	70
	Outlet	58	65	68	74	79	78	77	71	84
	Break-Out	50	58	55	50	56	56	59	45	64
2	Inlet	53	58	60	56	61	60	57	47	67
	Outlet	54	63	65	70	76	74	72	66	80
	Break-Out	48	55	51	47	54	53	55	40	61
3	Inlet	49	55	58	53	57	57	55	46	64
	Outlet	52	59	62	68	73	72	71	65	78
	Break-Out	44	52	49	44	50	50	53	39	58
4	Inlet	51	56	58	54	59	58	55	45	65
	Outlet	52	61	63	68	74	72	70	64	78
	Break-Out	46	53	49	45	52	51	53	38	59
5	Inlet	40	46	49	44	48	48	46	37	55
	Outlet	43	50	53	59	64	63	62	56	69
	Break-Out	35	43	40	35	41	41	44	30	49
6	Inlet	44	49	51	47	52	51	48	38	58
	Outlet	45	54	56	61	67	65	63	57	71
	Break-Out	39	46	42	38	45	44	46	31	52

MOUNTING ACCESSORIES



MBE
 Electric heater.

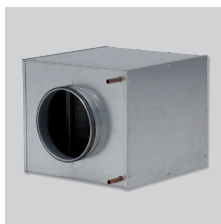

MBW
 Hot water coil.



MFL-G4
 Filtration boxes.



SIL
 Sound attenuators.



ACOPEL F400 N
 Circular flexible connector.



APC
 Discharge protection guards for direct connection to the inlet-outlet flange. (please see pages Mounting Accessories).



KSE-45
Flexible supports
 Rubber anti-vibration mounts to reduce vibration and noise transmission to the installation. (1KSE = set of 4 supports per bag).

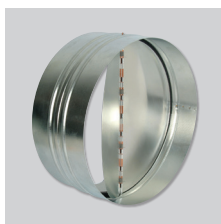

CAR
 Circular back draft shutters.

ELECTRICAL ACCESSORIES



REB-1N / REB-1NE
REB-2,5N / REB-2,5NE
 Electronic, single phase speed controllers.



RMB-1,5
 Auto transformer single phase speed controllers.



ON/OFF
IP55 SWITCH



PULSER
 Single phase/three phase electric heater controller.



TG-K330
 Duct temperature sensor.
TG-R530
 Room temperature sensor.



TTC-2000
TTC-2000 + TTS-1
 Three phase electric heater controller. The TTC-2000 needs an external temperature sensor to control the heater (TG-K330 or TG-R530).